

USER AND INSTALLATION MANUAL

versione 1.6 - 2020

Thank you for choosing the MyMeter system, we have made it and produced it with care so that it can be used reliably over time, provided it is installed and used following the instructions provided in this manual.



La centralina MyControl CPU WiFi del sistema MyMeter dispone di un mini access point WiFi IEEE 802.11 b/g/n incorporato che consente un facile uso attraverso un qualsiasi device dotato di wifi, e grazie alla webapp incorporata non c'è bisogno di installare alcuna app.

The MyControl control unit of the MyMeter system has a built b / g / n mini wifi access point that allows easy use through any smartphone with wifi, and thanks to the built-in webapp there is no need to install any app and it tablets and PCs.

WoodControl Information provided in this manual are covered by copyright laws in Europe and worldwide, you are not allowed to copy, even parts of this manual without prior writ Actual products may slightly differ from the ones depicted in this manual without prejudice of its validity.

MyMeter is a system designed to process information related to the level of moisture and te wood by the mean of a network of permanently deployed sensors. It integrates a WiF is possible to access to a web-application that feature an easy to use and intuitive interface. The application allo read the stored information and settings, with any smartphone, tablet or PC eq browser web, with no need to install any specific application. Moisture in wood is due to water that can be normally found in the wood grain, and components that constitutes the very same fibrous structure of the wood, therefore it (not to be confused with the relative humidity in the air) and it depends by the temperature of t our sensors include a thermometer that is conceived to touch the wood once the sensor i of the electrodes that measure the humidity. Among the technologies known at state conductivity that has shown to be well suited to measure the moisture well into the wood and not only on the surface. We devoted several months of research with several wood samples and condition between reliability, precision and relative low cost, to achieve the best solution on t system is intended to provide. Our circuitry is derived from instrumentation tech compensations for natural phenomenon that may occur on struc oscillation of the moisture (that do not significantly impact the wood being damaged), di fields and even the possibility of galvanic cell effects. Basic sensors however are not intended to work on heavily humid/wet wood unless a s special situations specific sensors are required. Each sensor has a high sensitive detecti which perform the required basic compensations network to the central unit that keep under control all the sensors and is able to d collects the information providing a time possible spurious non-significative variations creating a history database that cannot be solution that can provide trending information useful to predict and anticipate possi significative reduction of the risk and costs associated with the absorption of excessive amount The system is composed by a central unit MyControl to which up to sixteen sensors may be connected host up to six sensors, extended kit may host up to sixteen). MySenseBus sensors ca recommended.



The installation of the sensors, the electrodes and any detectors outside the sensor, following the instructions provided, and exclusively by qualified personnel.



Hold the electric board by the edges and avoid touching the electrical connections (easily visible by metallic-silver appearance). We recommend to use anti-static precautions. Avoid getting the electrodes dirty, always drill the wood leaving no traces of oil or grease.

WARNING: the electrodes are made out of special steel which can be very sharp. Screw the electrodes with screwdriver equipped with nut driver, move slowly to avoid overheating and resulting in burning effect on wood. To reduce the risk of overheating the electrodes, they can be slightly dampened, this also helps to screw them in.

Note: Do not force bend or pull the board, this can result in damaging the components.

Note: Only use nuts and washers supplied, do not use zinc-plated, nickel-plated, brass-plated, iron or mild steel. Only use nuts and washers in AISI304 / 316 (A2) STEEL. The use of inappropriate accessories may cause incorrect readings or internal erosion resulting in irreparable damage to the board and electrodes.

Note: Avoid touching the electrode boards with greasy or dirty hands (PCB side). If it happens accidentally, clean well with isopropyl alcohol. The presence of electrolyte fluids can cause incorrect readings or can erode the electric board.

Kit – what is provided

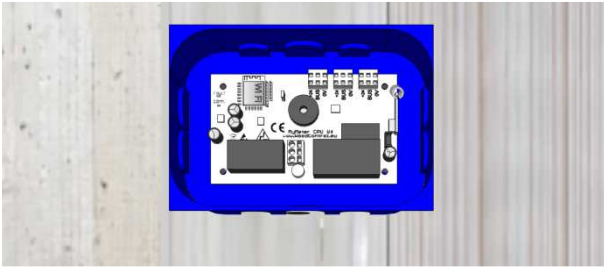

MyControl CPU WiFi

Power unit with case box for light wall dimension 199,3x142,8x70 mm



MyAlarm

LED Alarm with case box for light wall diam. 68 mm - QR CODE cover



MySenseBus

Moisture and temperature sensor via bus with case box 110x72,5 mm - n° 1 Temperature Probe with 1 mt long cable - n° 2 Moisture probes with 1/2 or 3 mt long cables - n° 2 Gel Box - n° 4 electrodes L 100 mm



MySenseRadio

Moisture and temperature sensor via WiFi with case box 110x72,5 mm - n° 1 Temperature Probe with 1 mt long cable - n° 2 Moisture probes with 1/2 or 3 mt long cables - n° 2 Gel Box - n° 4 electrodes L 100 mm



Bus

Cable Bus connecting the Power Unit and sensors L=100 meters

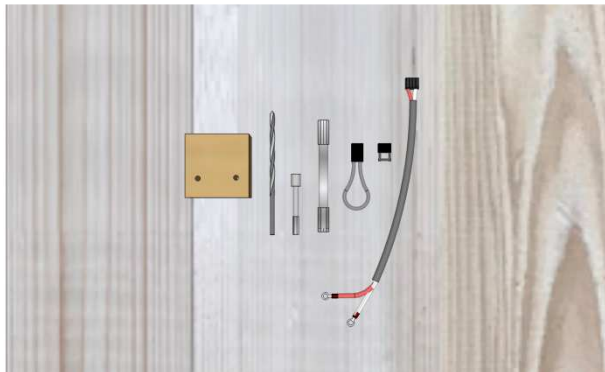

Fix Kit

Installation kit with Drill guide/ Drill/ Key screws electrodes/ Fastening Key/ Test Resistance/ grometer Adapter/ SpeedUp

Required for assembly

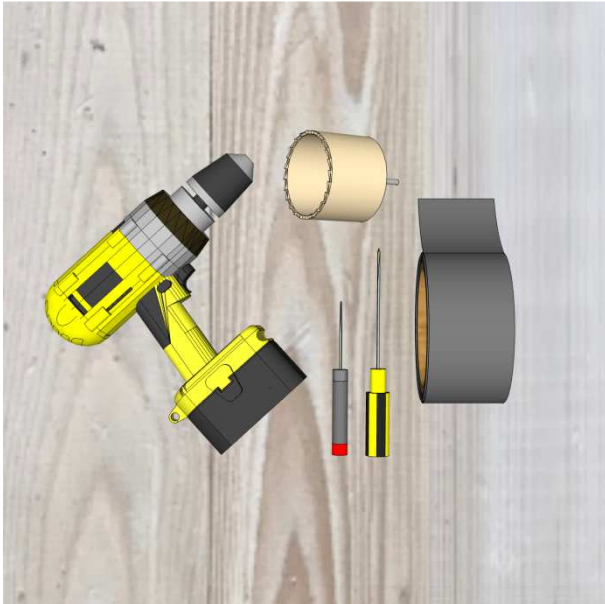

NON INCLUSO

Drill
Holesaw drill bit Ø 68 mm
Masking tape
Small Philips screwdriver
Small screwdriver

Electrical diagram and technical specifications of the MyMeter system

The MyMeter system consisted of:

- MyControl CPU WiFi, a control unit powered by 230 VAC, connected to the sensors MySenseBus or MySenseRadio through the bus connection or wifi.
- MyAlarm a Led alarm connected by cable to the WiFi control unit.
- MySenseBus, a sensor connected to the MyControl CPU WiFi which transmits measured moisture and temperature levels. The sensors are connected via the Bus cable, up to a maximum of 16 units per control unit with a maximum distance of 100 meters of connecting cables. Each sensor can have up to 2 moisture reading points and 1 temperature reading point. Each reading point can be orientated and positioned to a maximum of 1,2 or 3 meters distance from the sensor.
- MySenseRadio, a sensor connected to the MyControl CPU WiFi which transmits measured moisture and temperature levels. The sensors are connected via wi fi, up to a maximum of 16 units per control unit. Each sensor can have up to 2 moisture reading points and 1 temperature reading point. Each reading point can be orientated and positioned to a maximum of 1,2 or 3 meters distance from the sensor.

Example wiring diagram of the MyMeter system

Specifications:

- The Bus line must be independent and divided from that normally used at 230 VAC.
- Length of the bus cable connecting the control unit and sensors max 100 meters
- Maximum sensors connectable in the same line max 8
- Sensors for system max 16
- Dry contact output cable length 2 meters (optional)

The connection must be carried out by a qualified person who will take full legal responsibility. The installation and connections must be done according to EN (or equivalent) for installation in the European Union, or according to your country's standards.

Where required, the mains power supply needs to be a rated voltage of 230 VAC \pm 10% single-phase, without earth connection, and the electronic boards must be inserted in the appropriate electrical boxes to form a double insulation circuit. It is forbidden to use metal boxes and lids or any other electrically conductive material.

The electrical connection to the 230 VAC must be done with suitable conductors and the cables/wires with no less than 0.75mm².

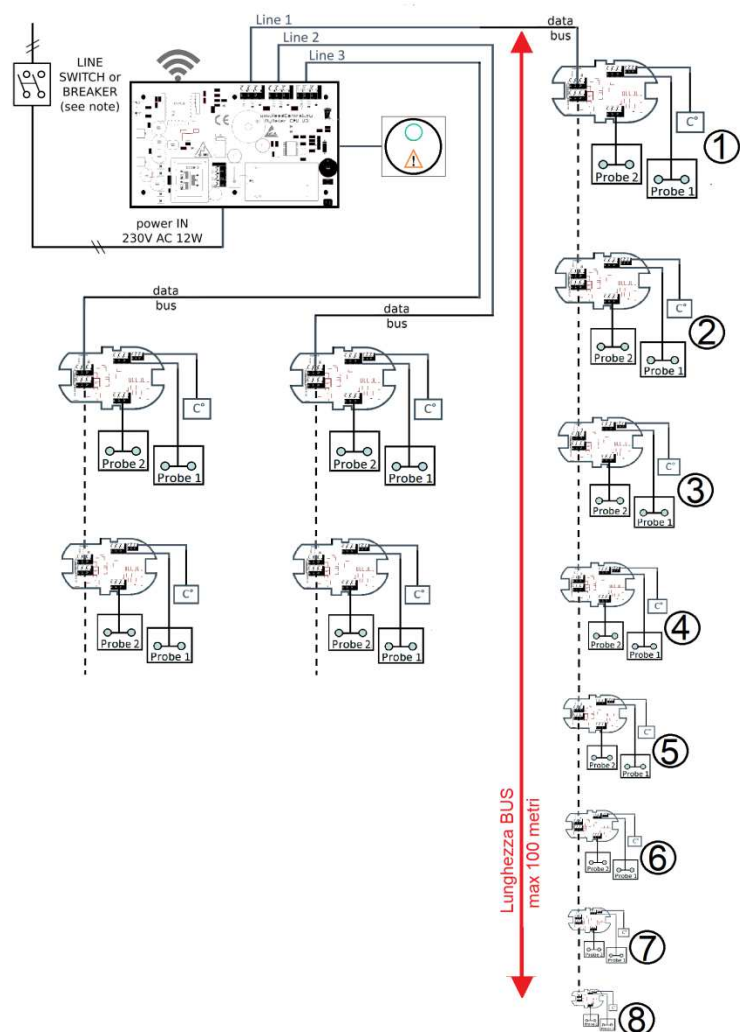

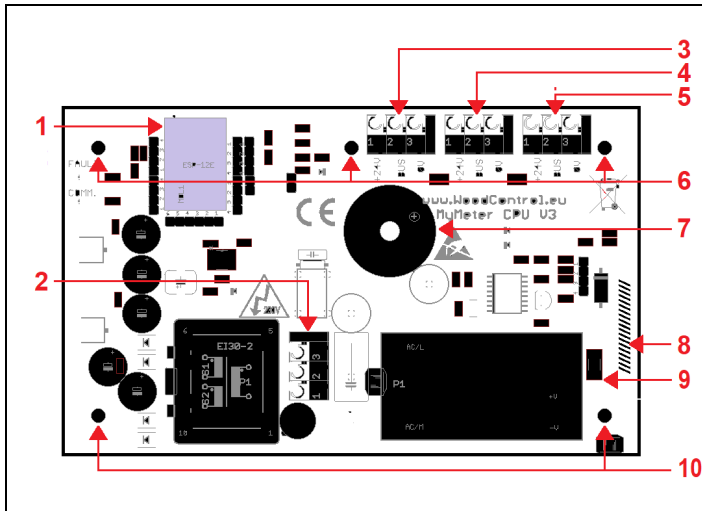

MyControl CPU

- 1) WiFi range is about 10 meters.
- 2) Power supply 230 VAC
- 3) Line 1 (connection with Bus to the sensor MyMeter) maximum length 100 meters.
- 4) Line 2 (connection with Bus to the sensor MyMeter) maximum length 100 meters.
- 5) Line 3 (connection with Bus to the sensor MyMeter) maximum length 100 meters.
- 6) Holes for screwing onto the junction box .
- 7) Alarm buzzer
- 8) WiFi antenna sensors
- 9) Connection of the MyAlarm cable.
- 10) Holes for screwing onto the junction box.

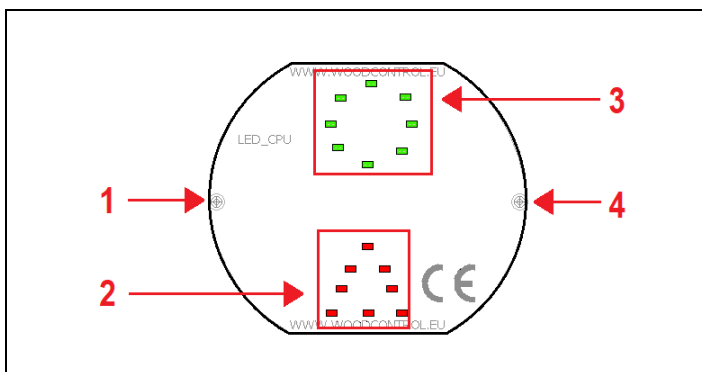

MyAlarm

- 1) Hole for fixing on the electrical box
- 2) Red led
- 3) Green led
- 4) Hole for fixing on the electrical box

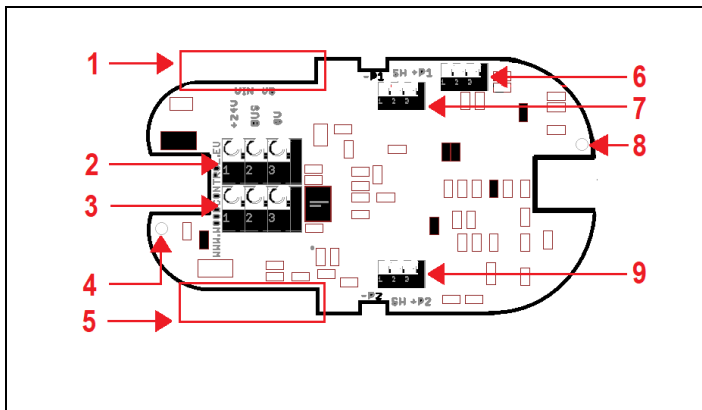

MySenseBus:



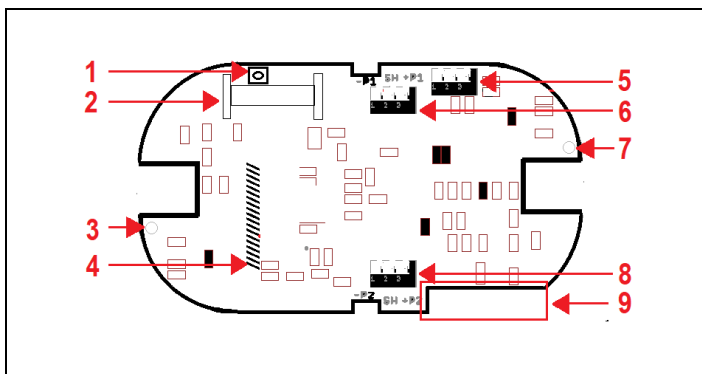

- 1) Entry for BUS cable.
- 2) Connection to BUS lead (between MyControl CPU WiFi cable MySenseBus Line 1/2/3 or between the sensors
- 3) Connection to BUS cable.
- 4) Holes for attaching to case.
- 5) Entry for the moisture probes.
- 6) Connection to temperature probe.
- 7) Connection to moisture 1.
- 8) Holes for attaching to case.
- 9) Connection to moisture 2..

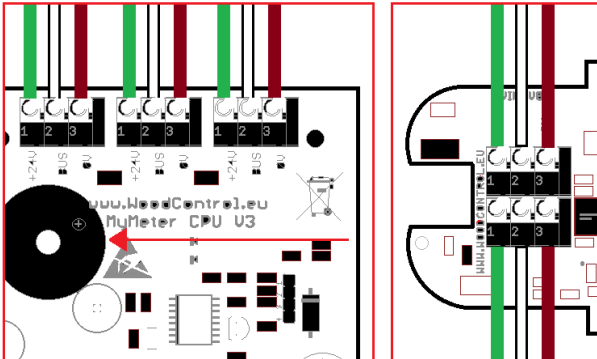

MySenseRadio

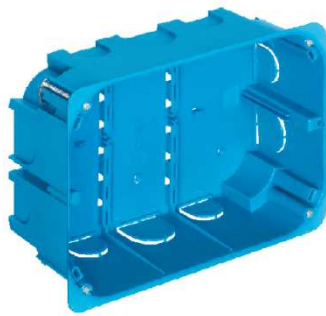
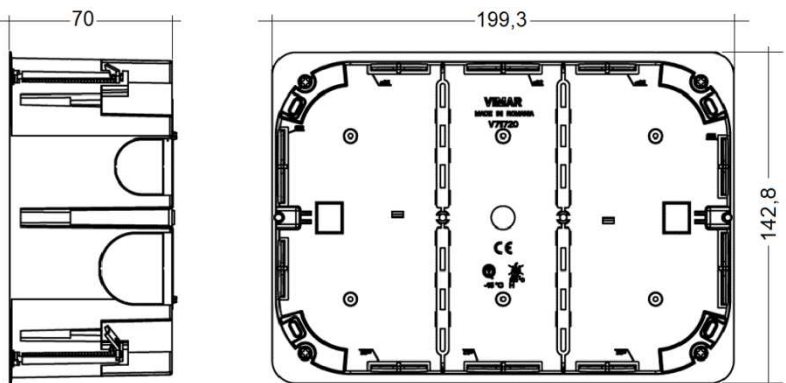
- 1) Connection button
- 2) Battery housing
- 3) Holes for attaching to case.
- 4) Antenna WiFi sensors
- 5) Connection to temperature probe
- 6) Entry for the moisture probes.
- 7) Holes for attaching to case.
- 8) Entry for the moisture probes.
- 9) . Entry for the moisture probes.

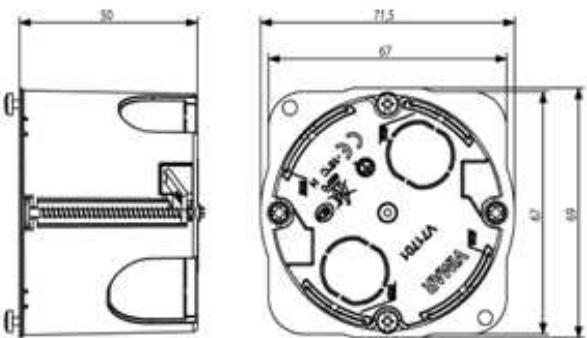
	<p>Connecting cable between: MyControl (WiFi base) and MySenseBus</p> <p>FROR 450/750V 3x0.50 Grey "C" Recommended internal colors: Brown, White and Green</p>
	<p>In 2019 the FROR cable will be substituted with new lead: FS18OR18 3x0,5 according to regulation UE305/11 which came into effect on 1st July 2017</p> <p>WARNING: The colors of the BUS link between control unit and sensors have to be the same at all times . The BUS wire for the connection between the control unit and sensors must have a separate installation unit</p>

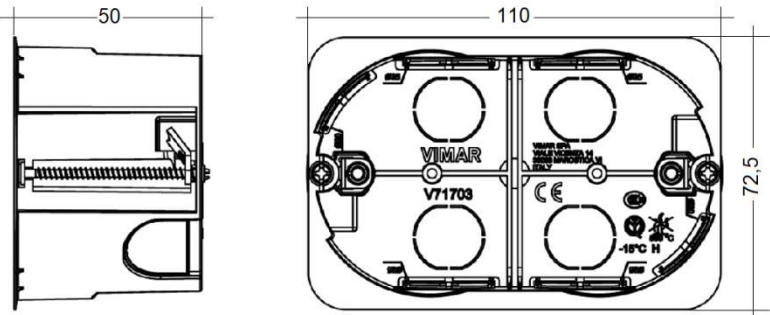
<p>Case for MyControl CPU WiFi</p>	 
<p>Case for MyAlarm</p>	 
<p>Case for MySense</p>	 

Where the system is installed

It is recommended to include the system in the critical points of the structure, such as: ground connection, opening and windows, terraces and flat roofs, bathrooms and shower trays and other provisions according to requirements. The material for which the system has been calibrated is construction material, such as fir, pine and larch. The construction typologies on which the system has been studied are: CLT, Timber Frame.

Example of system positioning:

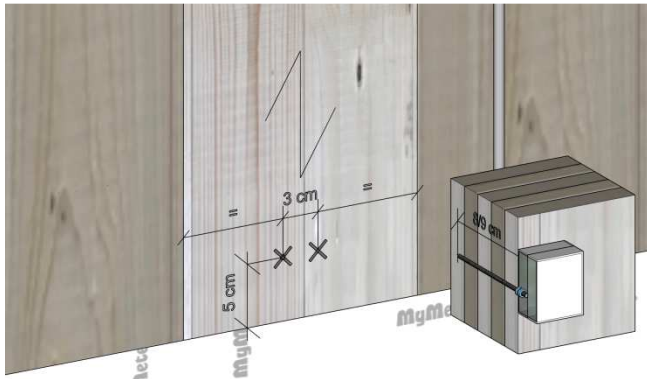

CLT

Position the electrodes transversely with respect to the wood fiber. Attach the electrodes to the middle of the CLT lamella and at a height of about 5 cm from the start of the wood.



Frame

Position the electrodes transversely with respect to the wood fiber. Fasten the electrodes about halfway up on the chassis platform.

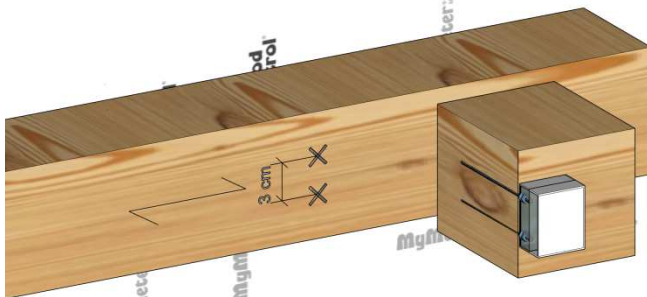

Timber

Position the electrodes transversely with respect to the wood fiber. Fasten the electrodes about halfway up on the chassis platform.

Info MySenseBus / MySenseRadio

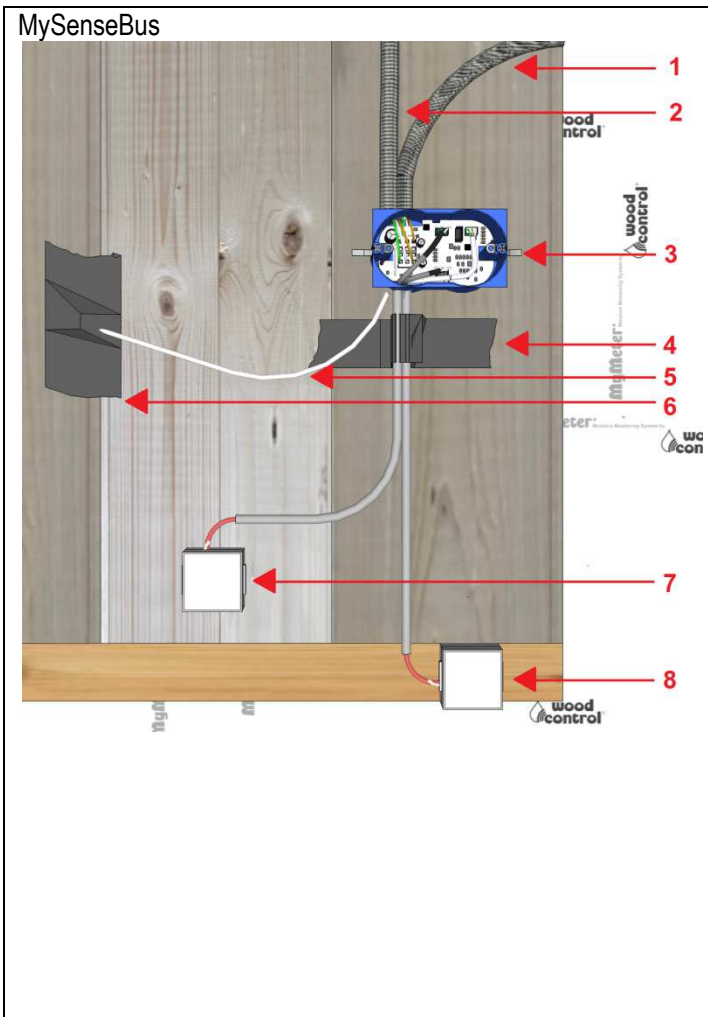

1) Cable ducting to connect Line 1/2/3 bus (connection between control unit and sensor).

2) Cable ducting to connect Line 1/2/3 bus (connection between sensor and sensor).

- 3) MySenseBus
- 4) Masking tape
- 5) Temperature probe
- 6) Masking tape
- 7) Moisture probe 1.
- 8) Moisture probe 2.

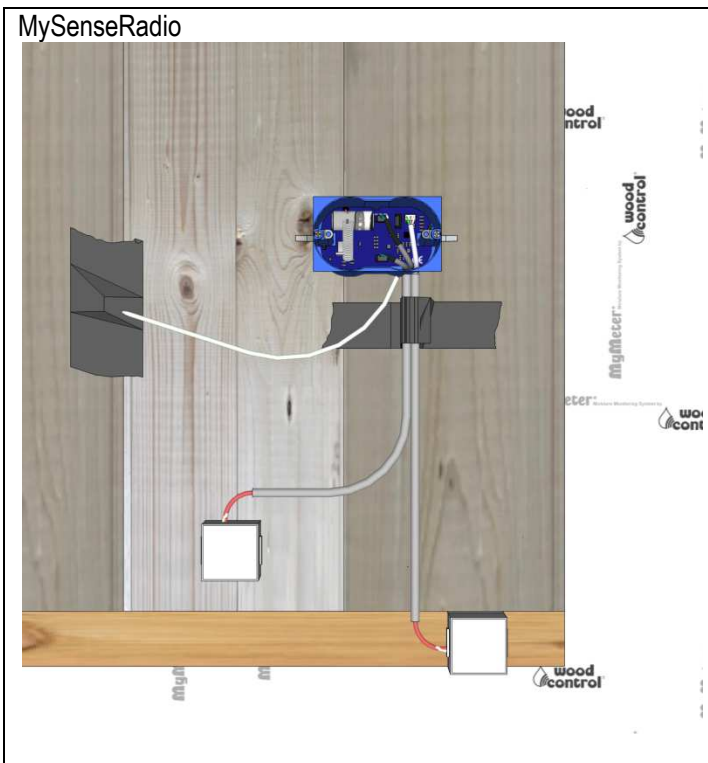

For the installation of the MySenseRadio sensor, the procedure is identical. Bus cable connections are not considered (points 1 and 2 of the previous figure)

Fase 1 Installing MySenseBus

- 1) Prepare Gel Box for the electrodes (Diagram 1)
- 2) Mark position where electrodes are placed (Diagram 2).
- 3) Position the drill guide in the center and drill with provided drill bit (Diagram 3).
- 4) Drill until you reach the necessary depth to screw in the electrodes (Diagram 4).
- 5) Screw the electrodes with Gel Box onto wood using supplied screwdriver (Diagram 5).
- 6) Attach the wires of the Probe (Diagram 6)
- 7) Supplied nut driver (Diagram 7).
- 8) Insert gel into el Box (Diagram 8).
- 9) Close Gel Box (Diagram 9)
- 10) Mark position where to place Probe 2 cable (Diagram 10).
- 11) Repeat for the installation of second moisture probe (Diagram 11)
- 12) Fix the Moisture Probe with masking tape (Diagram 12).
- 13) Position Temperature Probe to wall and fix its with masking tape (Diagram 13)
- 14) Put the cable ducting in place with the Bus connection cable between probes and CPU (Diagram 14)

Figura 1

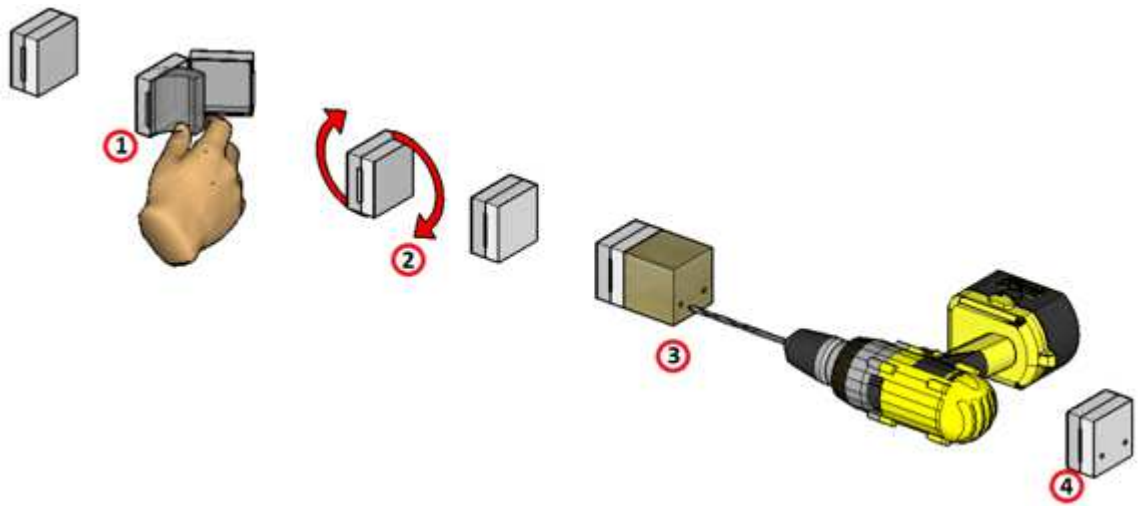

- 1) Open GEL BOX
- 2) Take out GEL
- 3) Close Gel Box and turn over
- 4) Hold and drill the back of the Gel Box

Figura 2



Figura 3



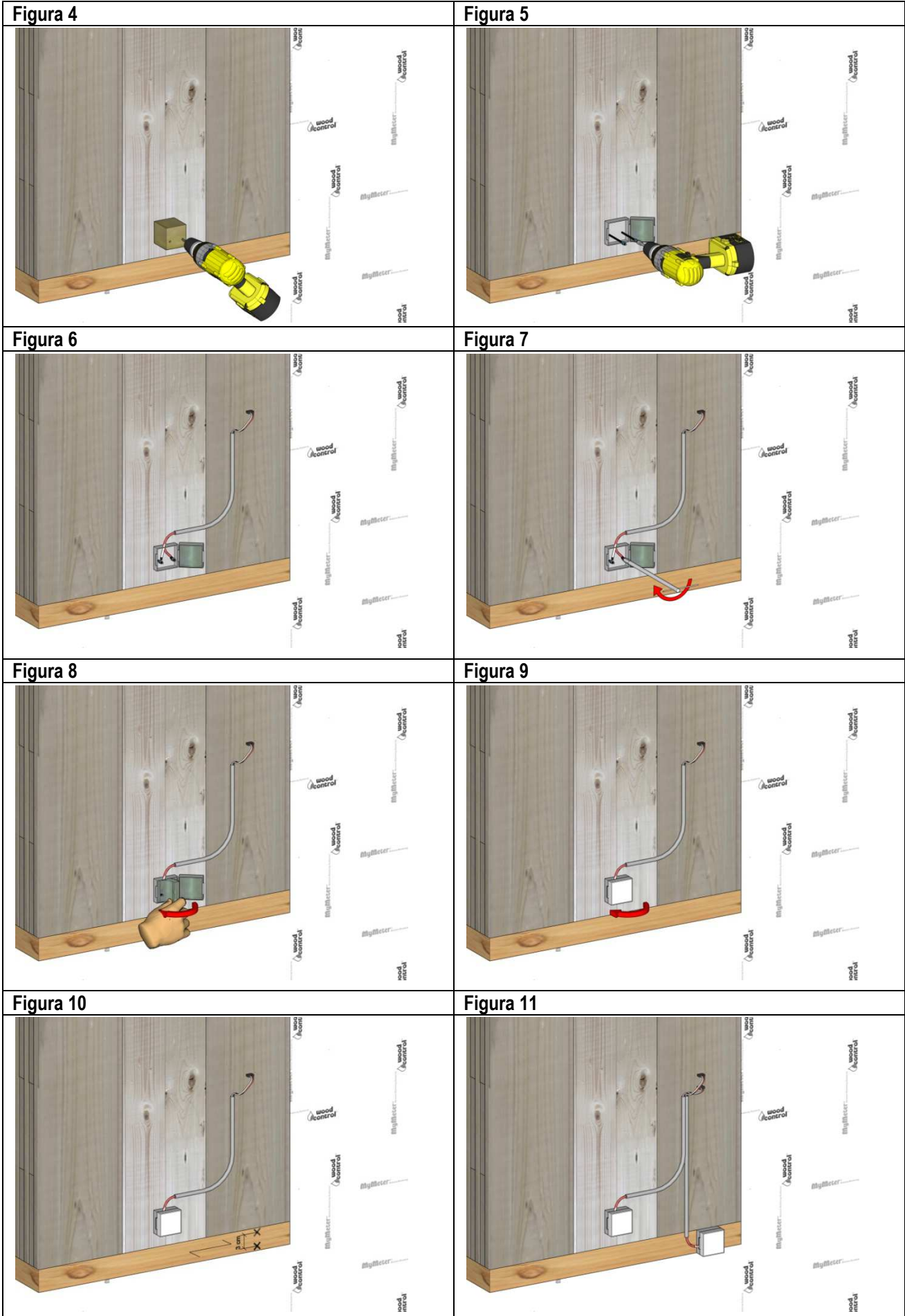

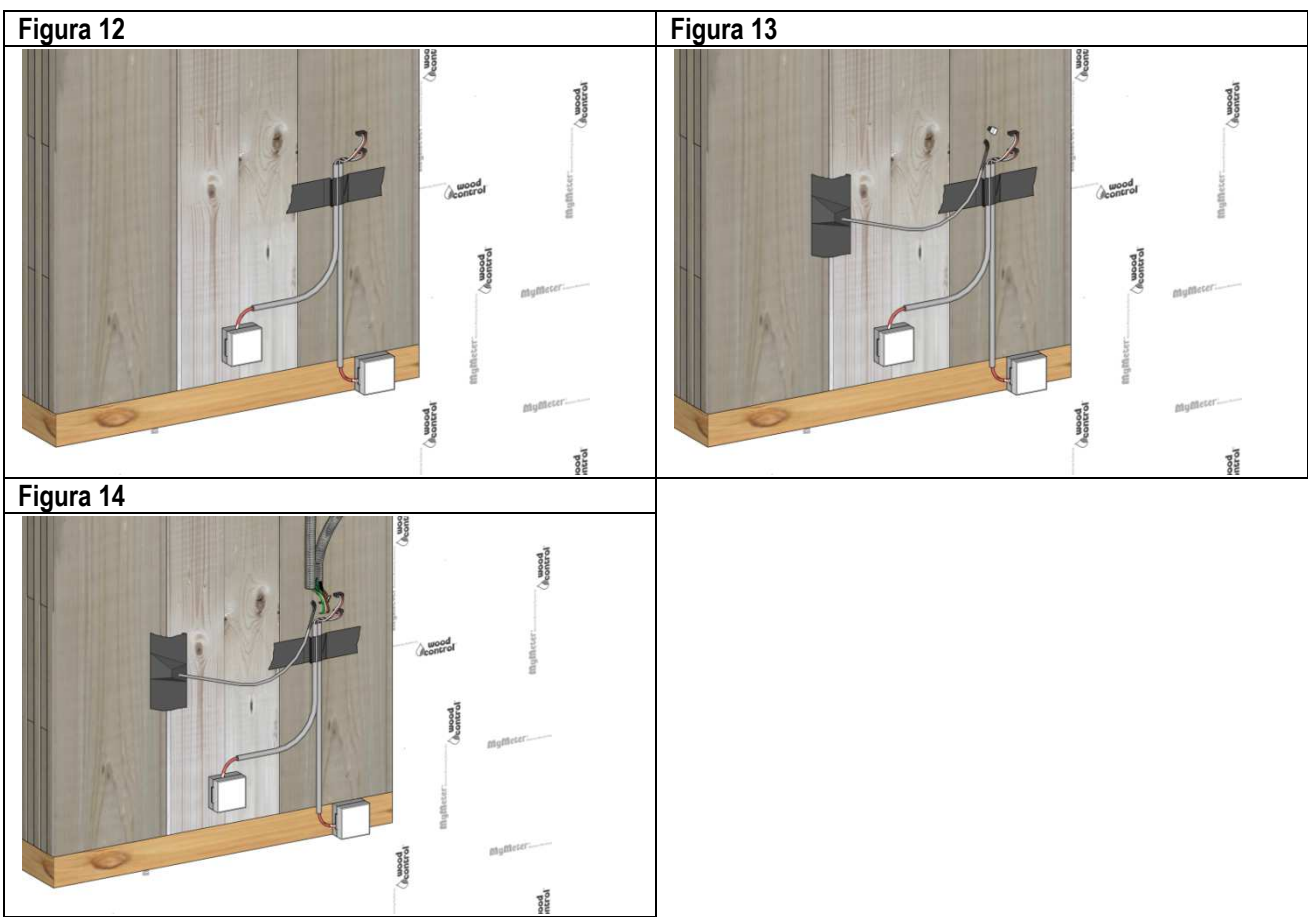

Fase 2 Connecting MySenseBus

The connection must be carried out by a qualified person who will take full legal responsibility. The installation and connections must be done according to EN (or equivalent) for installation in the European Union, or according to your country's standards.

Where required, the mains power supply needs to be a rated voltage of 230 VAC \pm 10% single-phase, without earth connection, and the electronic boards must be inserted in the appropriate electrical boxes to form a double insulation circuit. It is forbidden to use metal boxes and lids or any other electrically conductive material.

The electrical connection to the 230 VAC must done with suitable conductors and the cables/wires with no less than 0.75mm².

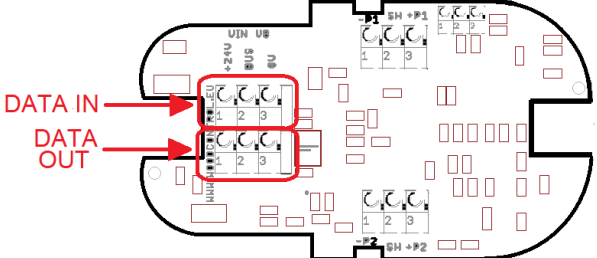
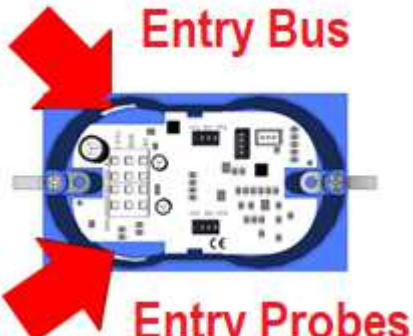
 <p>DATA IN</p> <p>DATA OUT</p>	<p>Pay attention to the connection of data bus connector wires, taking care that the wires are not inverted. In the event of a reversal of wires they may break..</p>
 <p>Entry Bus</p> <p>Entry Probes</p>	<p>Pay attention to the entry of the Bus cables and the entry of the probes. The two lines must be separated.</p>

- 15) Drill the wall with a holesaw drill bit \varnothing 68 mm (Diagram 15).
- 16) Put all components into the light wall (Diagram 16).
- 17) Fix the case on the light wall (Diagram 17)
- 18) Attach the sensor to the case, prepare the cables for connection (Diagram 18).
- 19) Connection Temperature Probe to the sensor (Diagram 19)
- 20) Connect the Moisture Probes to sensor (Diagram 20).
- 21) Connect the communication bus cable between the sensors (Diagram 21).
- 22) Connect the communication bus cable between the sensor and Power Unit (Diagr. 22)
- 23) End to connection (Diagram 23)
- 24) Protect the MySenseBus sensor with a cover - plate (Diagram 24)

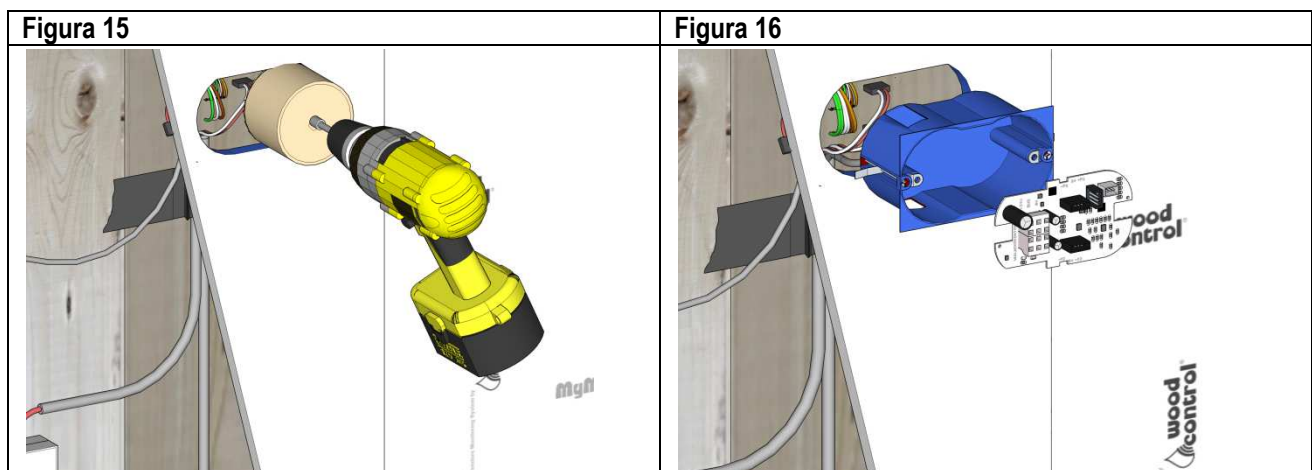

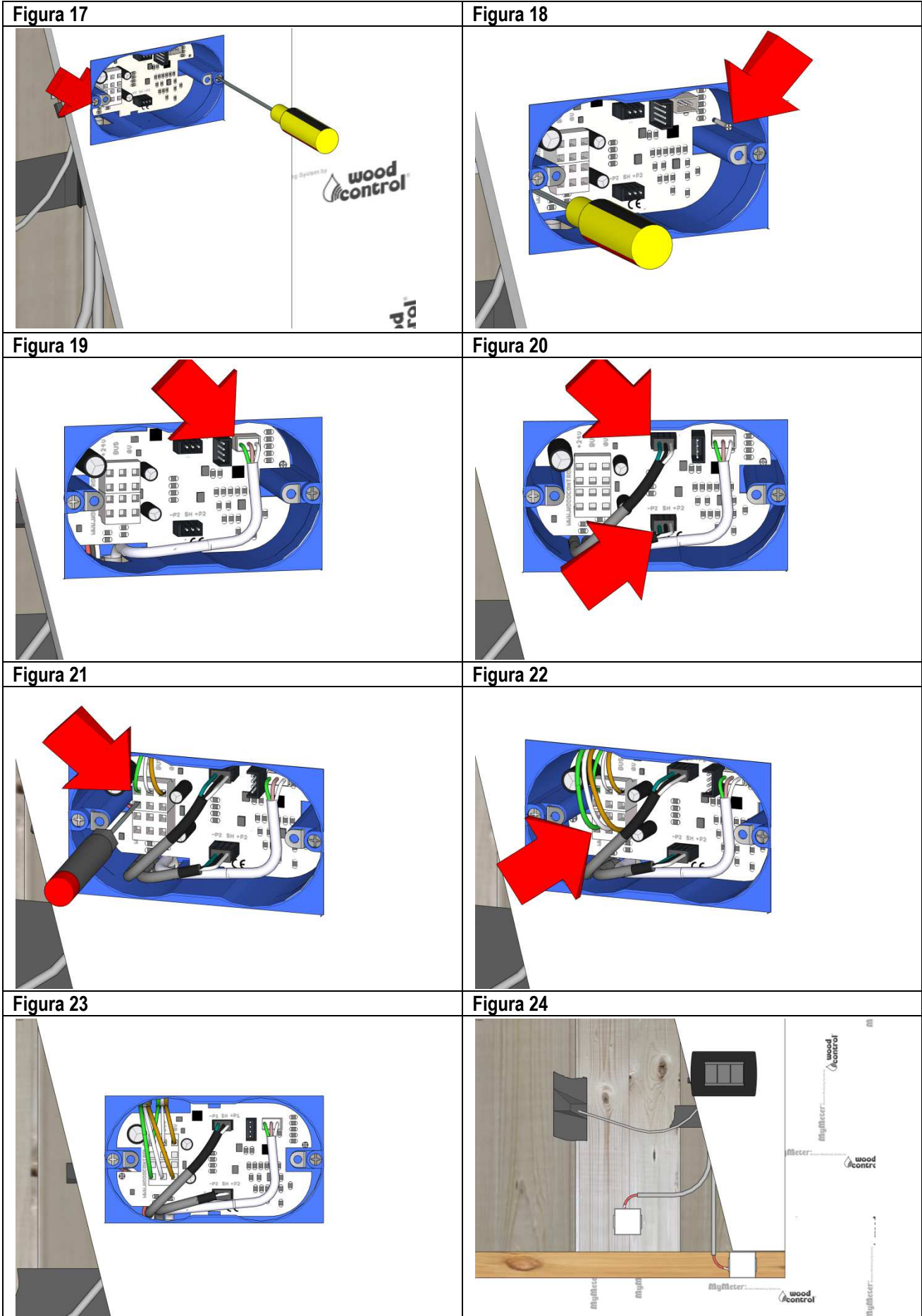

Fase 1 Installing MySenseRadio

- 25) Prepare GEL BOX for the electrodes (Diagram 25)
- 26) Mark position where electrodes are placed (Diagram 26).
- 27) Position the DRILL GUIDE in the center and drill with provided drill bit (Diagram 27).
- 28) Drill until you reach the necessary depth to screw in the electrodes (Diagram 28).
- 29) Screw the electrodes with GEL BOX onto wood using supplied screwdriver (Diagram 29).
- 30) Attach the wires of the PROB (Diagram 30)
- 31) Supplied NUT DRIVER (Diagram 31).
- 32) Insert gel into GEL BOX (Diagram 32).
- 33) Close GEL BOX (Diagram 33)
- 34) Mark position where to place PROBE 2 cable (Diagram 34).
- 35) Repeat for the installation of second moisture probe (Diagram 35)
- 36) Fix the Moisture Probe with masking tape (Diagram 36).
- 37) Position TEMPERATURE PROBE to wall and fix its with masking tape (Diagram 37)

Figura 25

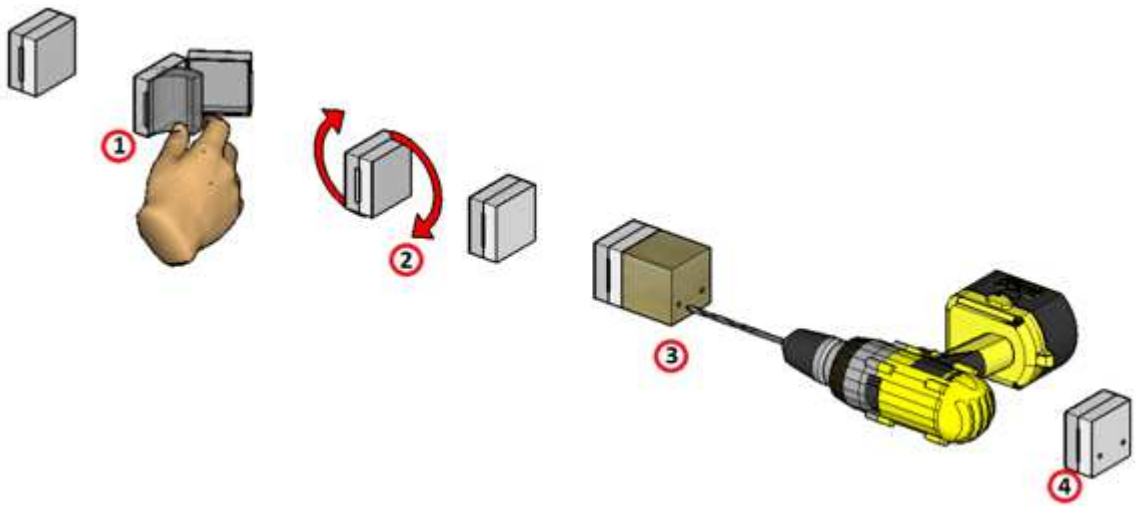

- 1) Open GEL BOX
- 2) Take out GEL
- 3) Close Gel Box and turn over
- 4) Hold and drill the back of the Gel Box

Figura 26



Figura 27



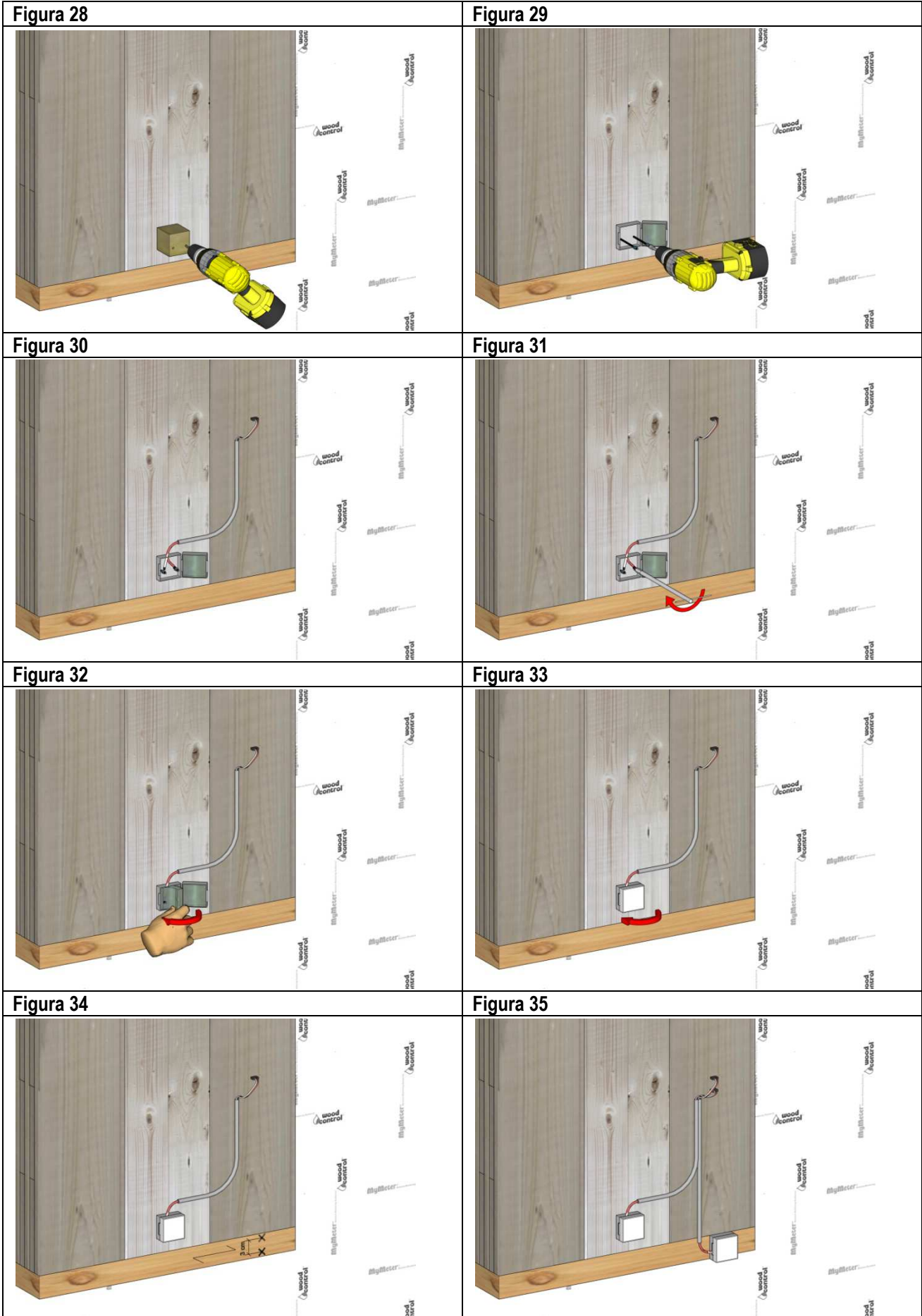

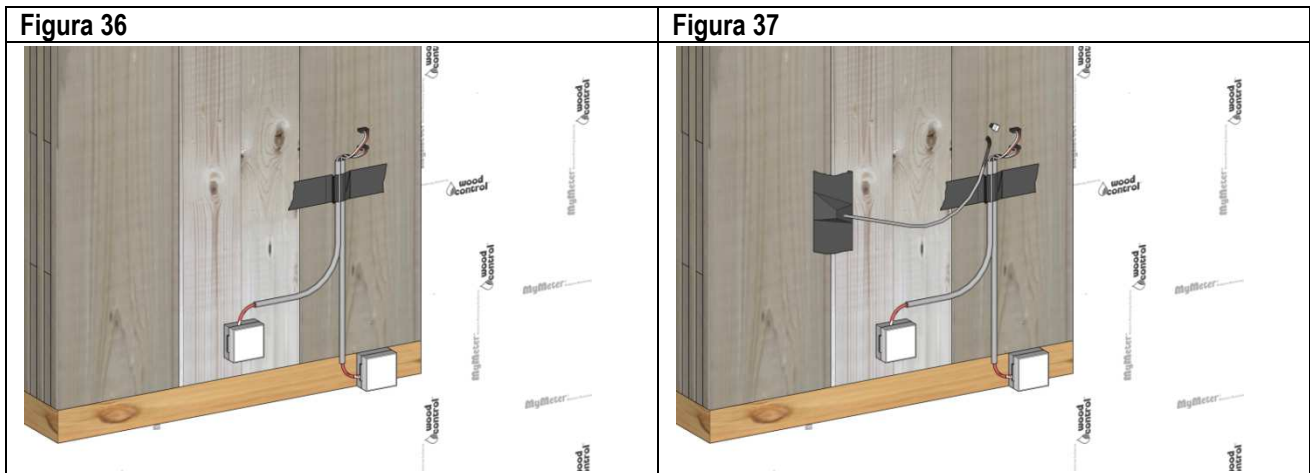

Fase 2 Connecting MySenseRadio

The connection must be carried out by a qualified person who will take full legal responsibility. The installation and connections must be done according to EN (or equivalent) for installation in the European Union, or according to your country's standards.

Where required, the mains power supply needs to be a rated voltage of 230 VAC \pm 10% single-phase, without earth connection, and the electronic boards must be inserted in the appropriate electrical boxes to form a double insulation circuit. It is forbidden to use metal boxes and lids or any other electrically conductive material.

The electrical connection to the 230 VAC must done with suitable conductors and the cables/wires with no less than 0.75mm².

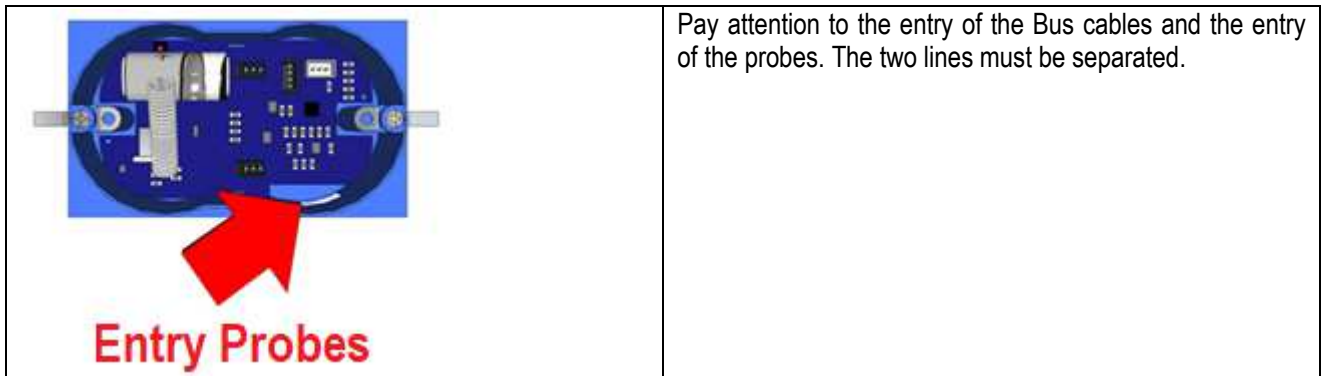

- 38) Drill the wall with a holesaw drill bit \varnothing 68 mm (Diagram 38).
- 39) Put all components into the MYSenseBus BOX (Diagram 39).
- 40) Fix the case on the light wall (Diagram 40)
- 41) Attach the sensor to the electrical box, prepare the cables for connection (Diagram 41).
- 42) Connection Temperature Probe to the sensor (Diagram 42)
- 43) Connect the moisture probe to sensor (Diagram 43).
- 44) Insert the battery (Diagram 44)
- 45) End to connection (Diagram 45)
- 46) Protect the MySenseBus sensor with a cover - plate (Diagram 46)

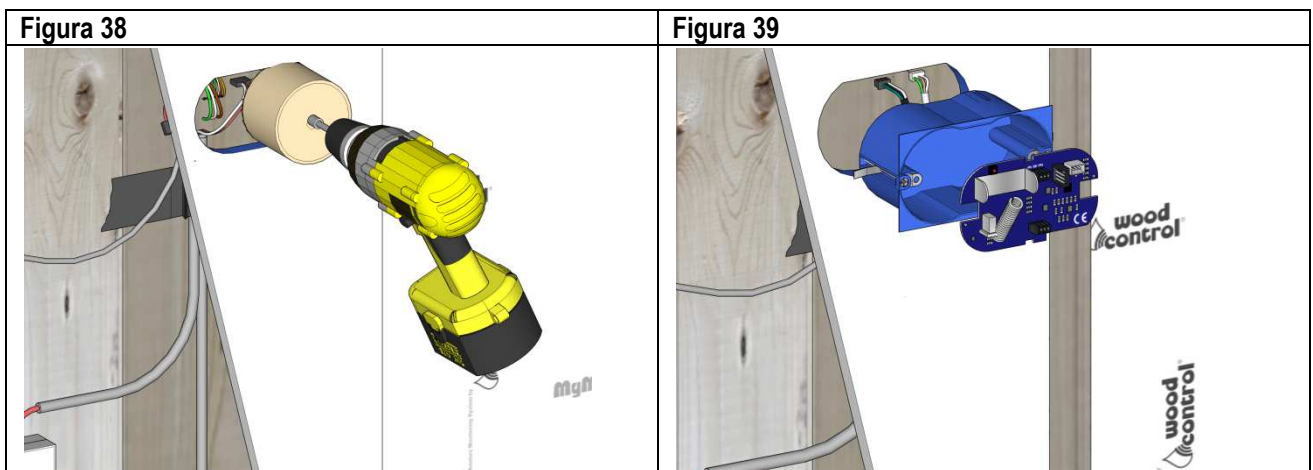

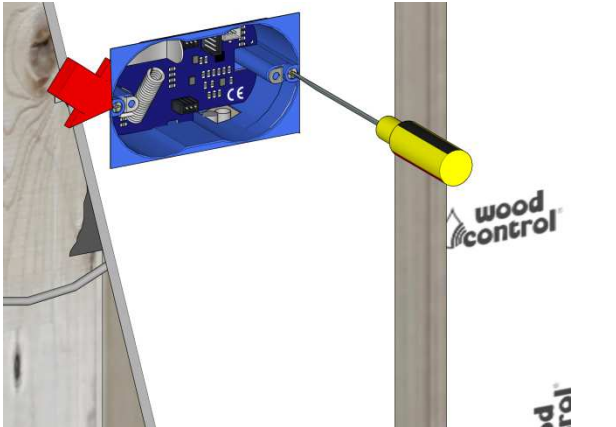
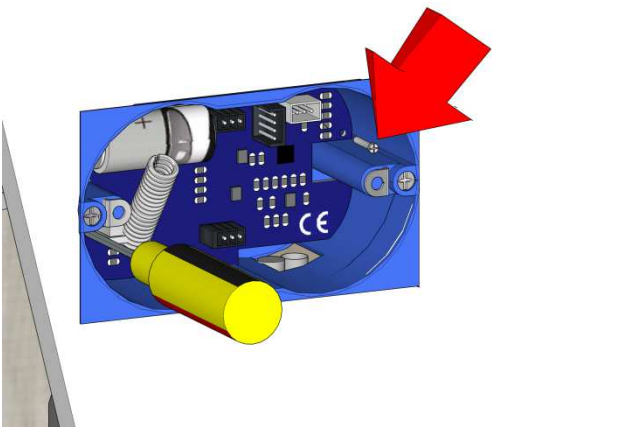
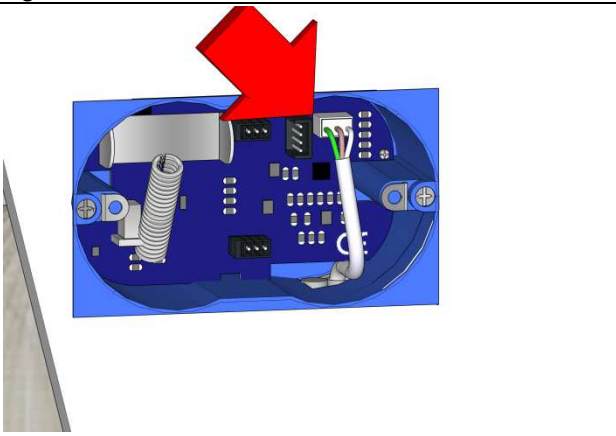
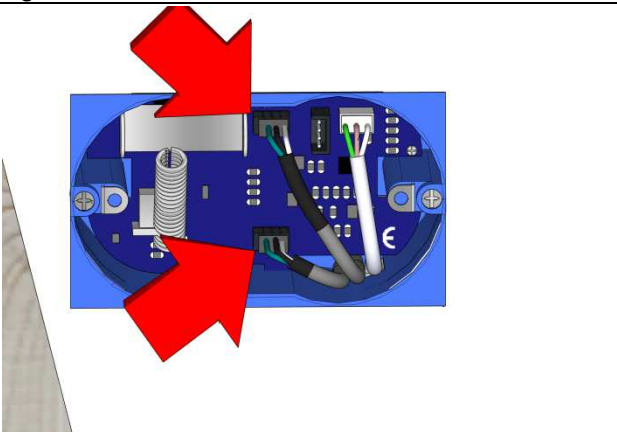
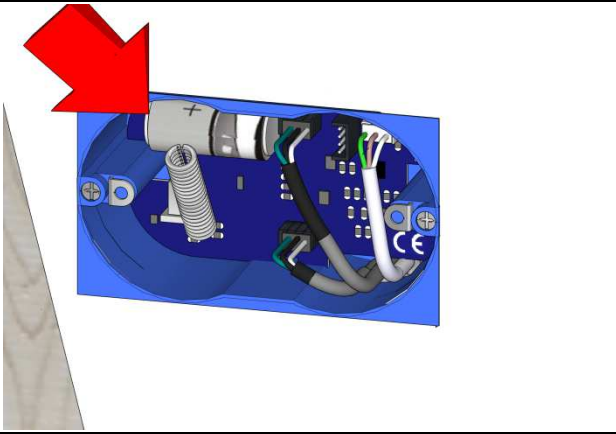
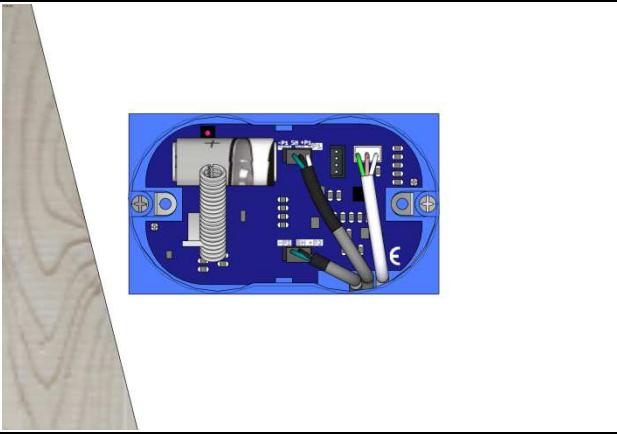
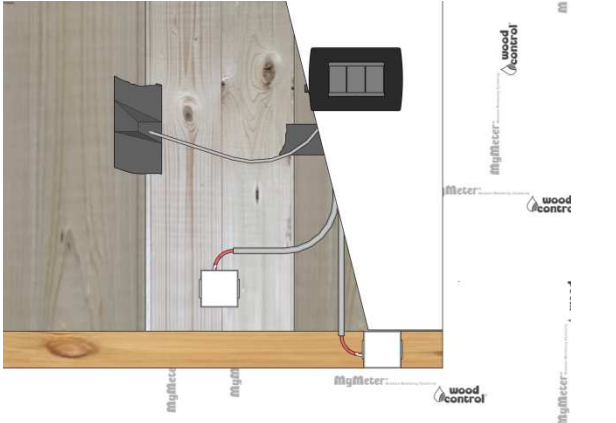
<p>Figura 40</p> 	<p>Figura 41</p> 
<p>Figura 42</p> 	<p>Figura 43</p> 
<p>Figura 44</p> 	<p>Figura 45</p> 
<p>Figura 46</p> 	

Fase 1 installing MyControl CPU WiFi

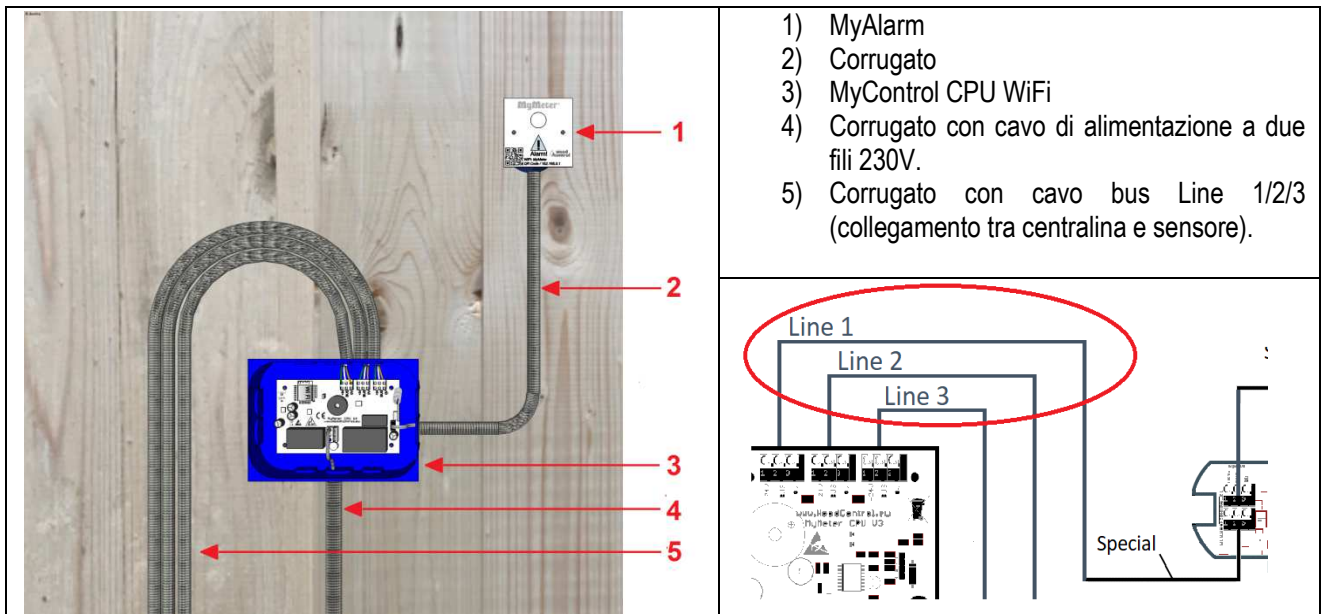

- 1) MyAlarm
- 2) Corrugato
- 3) MyControl CPU WiFi
- 4) Corrugato con cavo di alimentazione a due fili 230V.
- 5) Corrugato con cavo bus Line 1/2/3 (collegamento tra centralina e sensore).

- 47) Put the cable ducting in place with the BUS connection cable between the probes and the CPU (Diagram 47).
- 48) Put the cable ducting in place with Alarm Cable (Diagram 48)
- 49) Put the cable ducting in place with the 230 VAC power cable/lead for the control unit (Diagram 49).
- 50) Put the bus cable (Diagram 50)
- 51) Put the alarm cable (Diagram 50)
- 52) Put the power cable 230 VAC (Diagram 51)

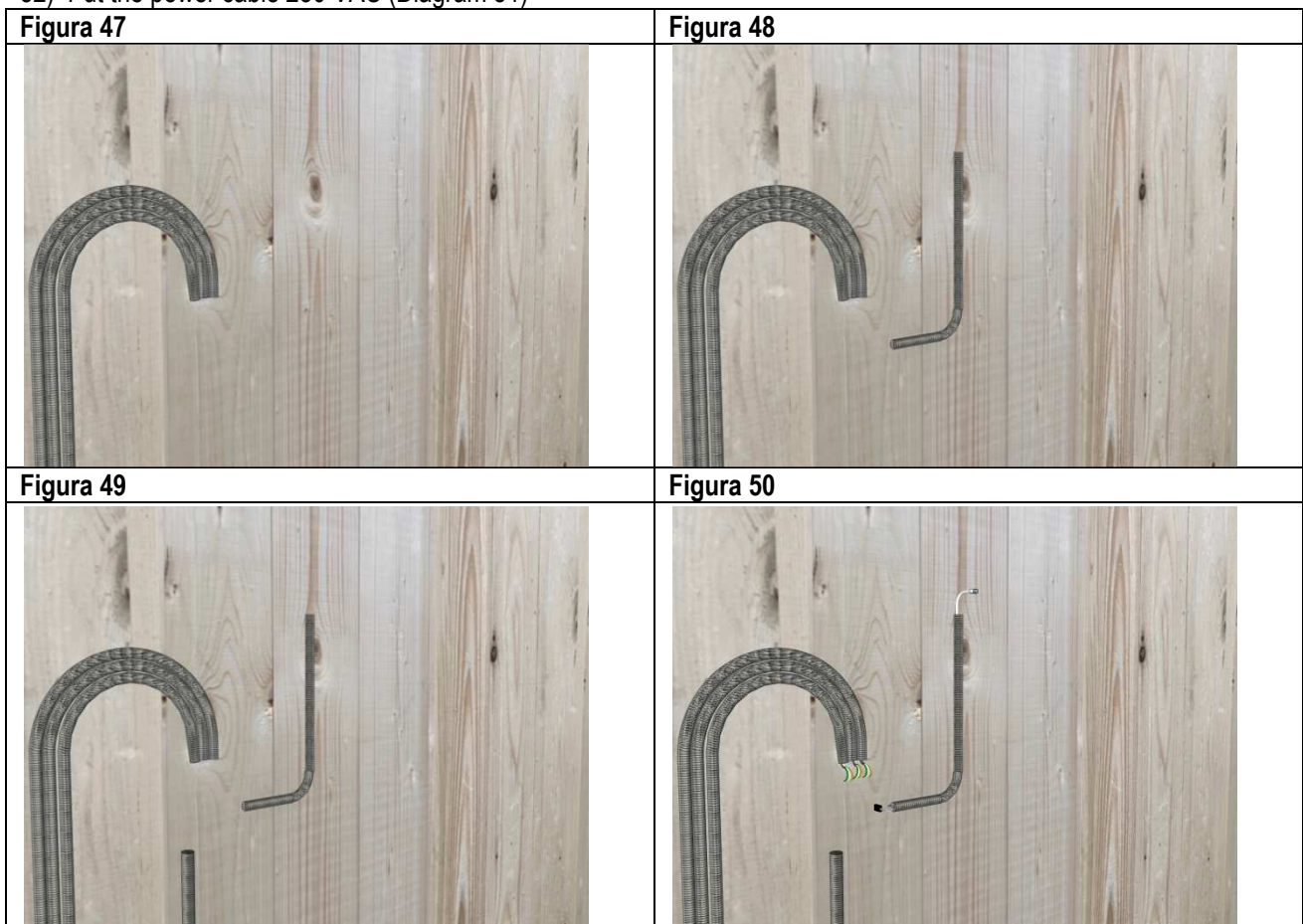

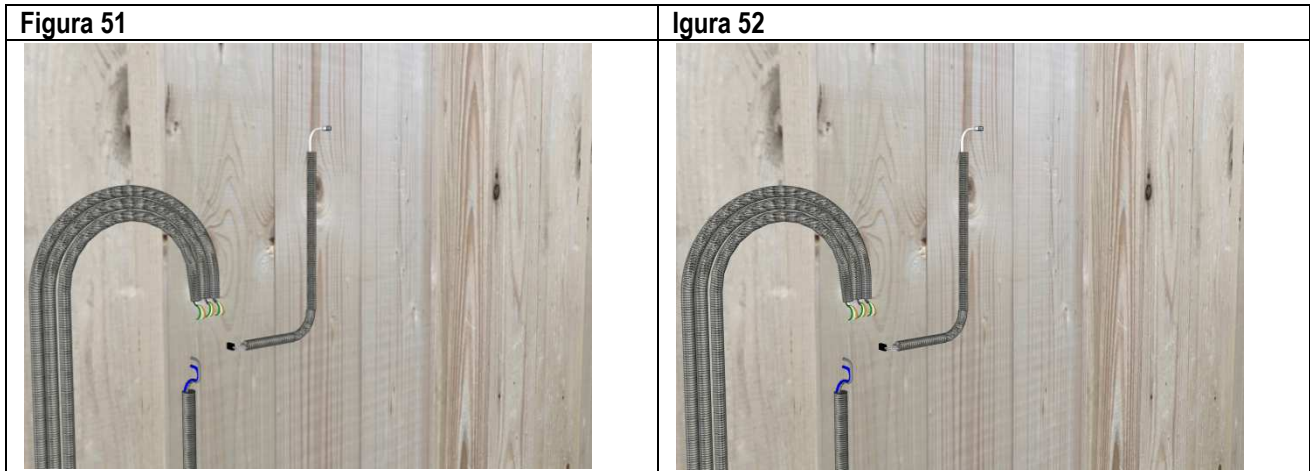

Fase 2 Connecting MyControl CPU WiFi

The connection must be carried out by a qualified person who will take full legal responsibility. The installation and connections must be done according to EN (or equivalent) for installation in the European Union, or according to your country's standards.

Where required, the mains power supply needs to be a rated voltage of 230 VAC \pm 10% single-phase, without earth connection, and the electronic boards must be inserted in the appropriate electrical boxes to form a double insulation circuit. It is forbidden to use metal boxes and lids or any other electrically conductive material.

The electrical connection to the 230 VAC must done with suitable conductors and the cables/wires with no less than 0.75mm².

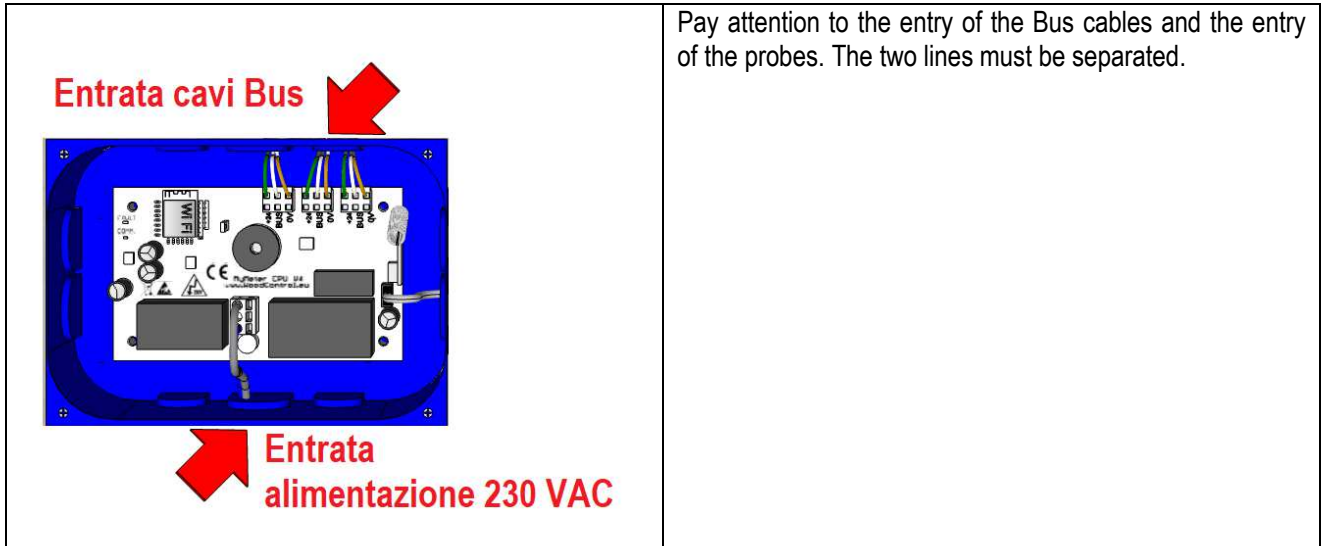

- 53) Drill the wall with a holesaw drill bit Ø 68 mm for the case of MyControl CPU WiFi (Diagram 53).
- 54) Drill the wall with a holesaw drill bit Ø 68 mm for the case of MyAlarm (Diagram 54).
- 55) Encase the case of the MyControl CPU WiFi and MyAlarm (Diagram 55).
- 56) Fix the case on light wall (Diagram 56)
- 57) Connect the line BUS to MyControl CPU WiFi (Diagram 57)
- 58) Connect the line BUS to MyControl CPU WiFi if necessary (Diagram 58)
- 59) Connect the power supply 230 VAC to MyControl CPU WiFi (Diagram 59)
- 60) Fix the case of MyAlarm to light wall (Diagram 60)
- 61) Connect the alarm cable to alarm Led (Diagram 61)
- 62) Close the Alarm Led with QR Code cover (Diagram 62)
- 63) Fix the screw of the covers (Diagram 63)

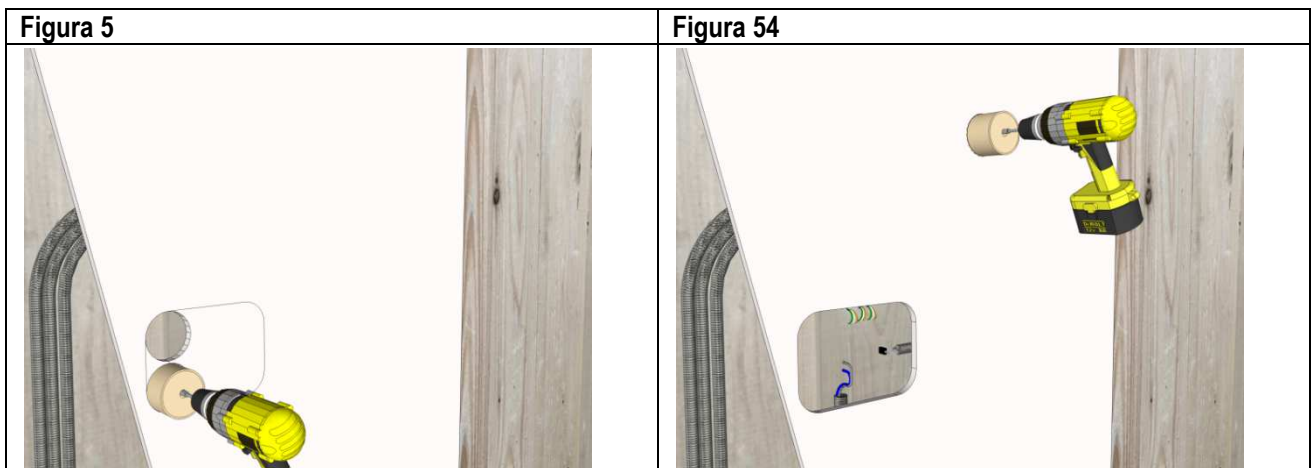

<p>Figura 55</p> 	<p>Figura 56</p> 
<p>Figura 57</p> 	<p>Figura 58</p> 
<p>Figura 59</p> 	<p>Figura 60</p> 
<p>Figura 61</p> 	<p>Figura 62</p> 

Figura 63



MyControl CPU WiFi Setup

The MyControl unit has a built-in portal with IEEE 802.11 b / g / n wifi access point, which you can connect with any smartphone, tablet or pc equipped with wifi.

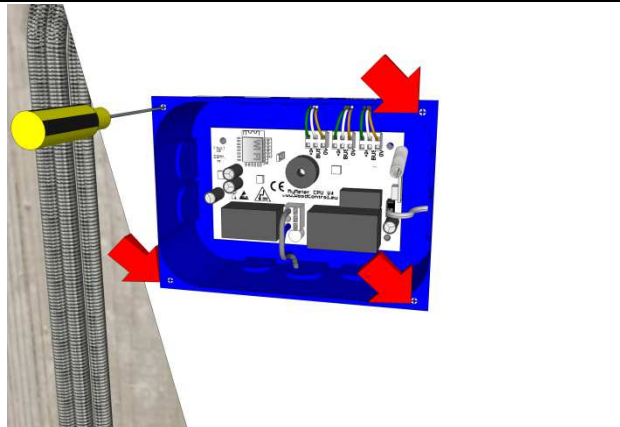
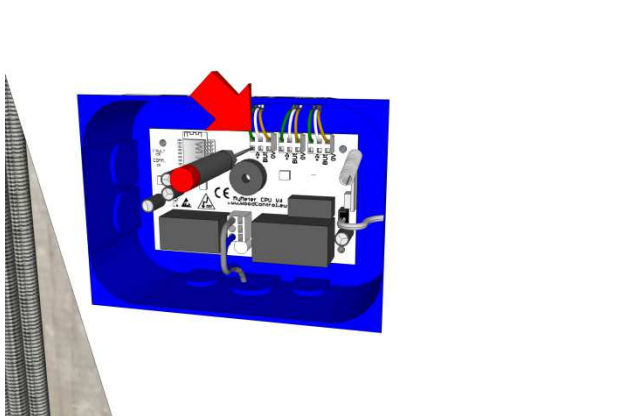
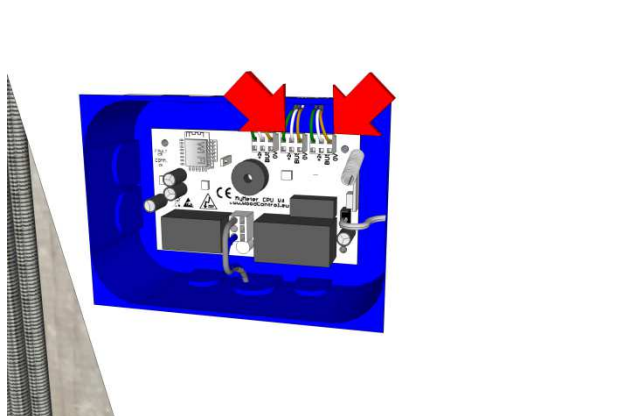
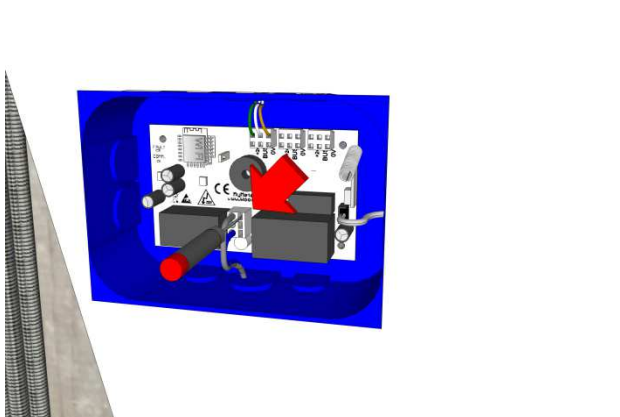
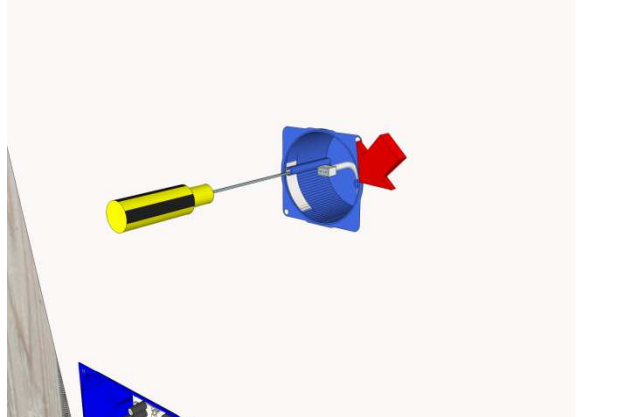
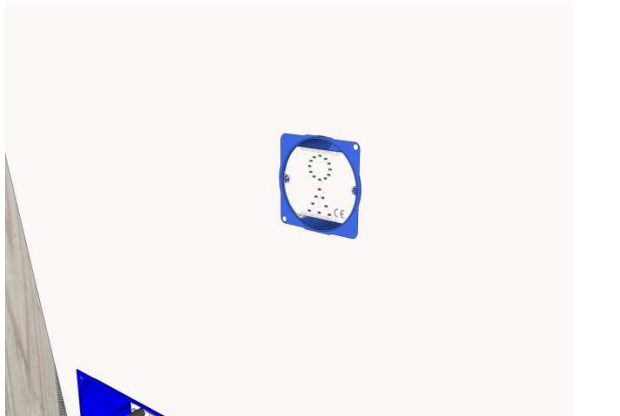
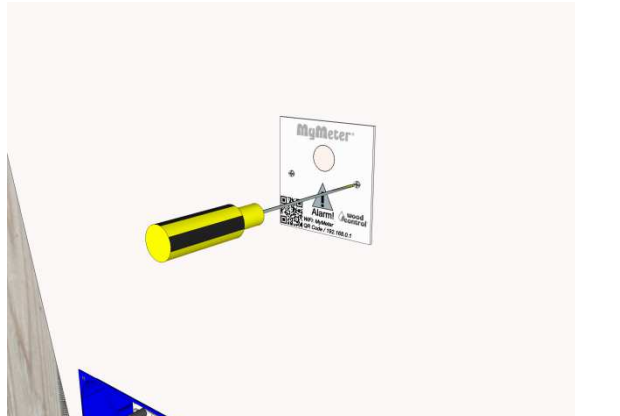
MyMeter is compatible with any DEVICE as long as it has an integrated WiFi connection (Diagram 1)

It doesn't need any kind of APP but can be accessed via the IP. 192.168.0.1

The MyControl CPU WiFi controller is equipped with an integrated WiFi system, which is slightly less powerful than other systems so to prevent interference with nearby WiFi.



Allocated ID:

For each order the system is set up in the factory, each sensor has its own ID number (from 1 to 16), also with a name for each number.

MyMeter quality control:

Before being shipped, the MyMeter system is tested in our Factory for at least a week. In the DATA HISTORY you will find the levels saved during the acceptance test.

(Diagram 3).

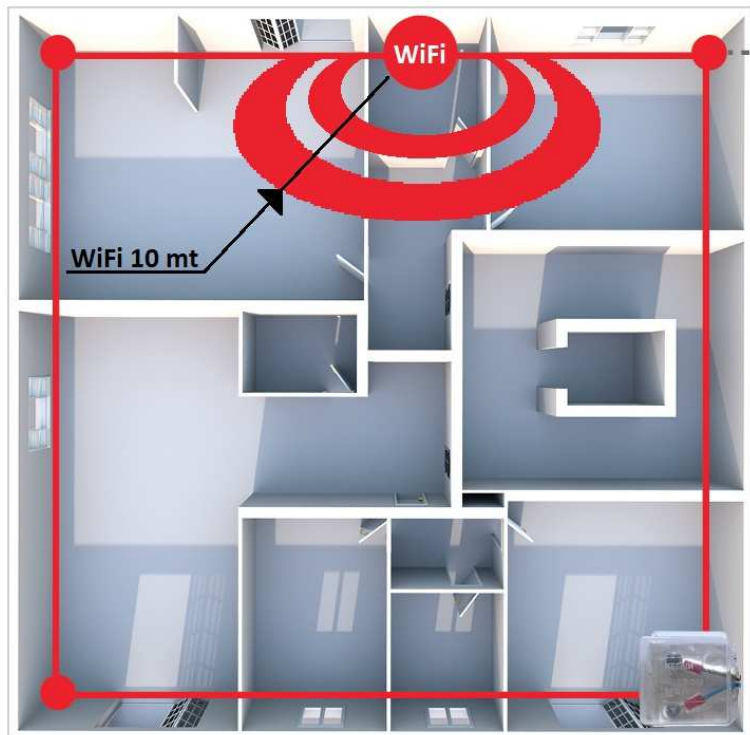

HISTORY FOR SENSOR Cam pt p		
[14]	30/11/2018	20.5%
[13]	28/11/2018	21.0% HUMID.
[12]	16/11/2018	12.5%
[11]	14/11/2018	12.5%
[10]	12/11/2018	12.5%
[9]	10/11/2018	12.5%
[8]	08/11/2018	12.5%

Fase 3 Starting Setup

Before selecting the system, check that all connections to the sensors and the control unit are correct:

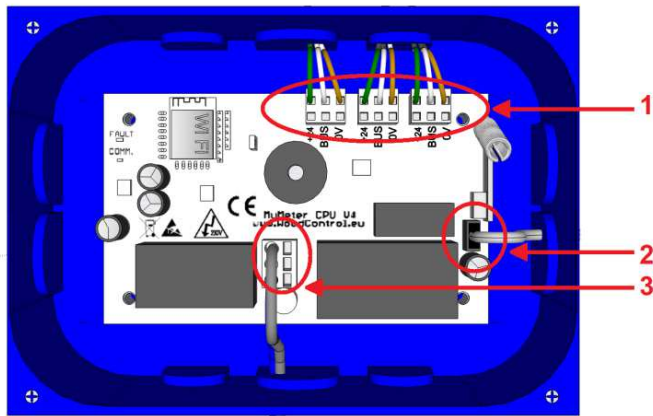

MyConstrol CPU WiFi

- 1) Connection to MySenseBus sensors with cable (attention to the Green-White-Brown sequence)
- 2) Connection to the MyAlarm sensor cable
- 3) 230 VAC power supply connection

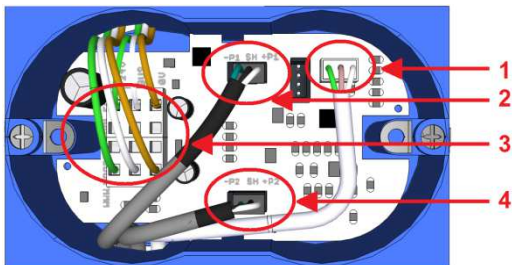

MySenseBus

- 1) Connection to the temperature probe
- 2) Connection to moisture probe 1
- 3) Connection to the bus (attention to the Green-White-Brown sequence)
- 4) Connection to moisture probe 2

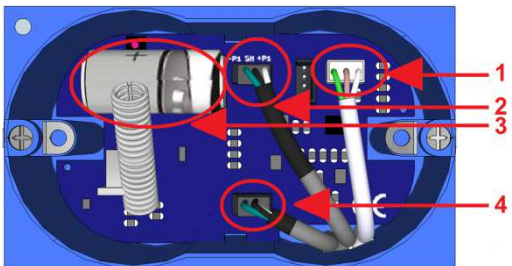

MySenseRadio

- 5) Connection to the temperature probe
- 6) Connection to moisture probe 1
- 7) Battery insert
- 1) Connection to Moisture probe 2

After powering up the control unit close with a device to the MyAlarm cover

- 1) On SETTINGS search for the WiFi network: MyMeter
- 2) Connect to the control unit by framing the QR Code (Is possible to entry on browser type IP: 192.168.0.1)
- 3) You access the HOME screen



Each sensor sends the moisture and temperature signal to the MyControl CPU WiFi control unit once an hour.

On startup, the HOME screen will not detect any signal.

At startup, you can speed up the signal with the SpeedUp (supplied) for the MySenseBus sensor

An acceleration button is located behind the battery for the MySenseRadio sensor.

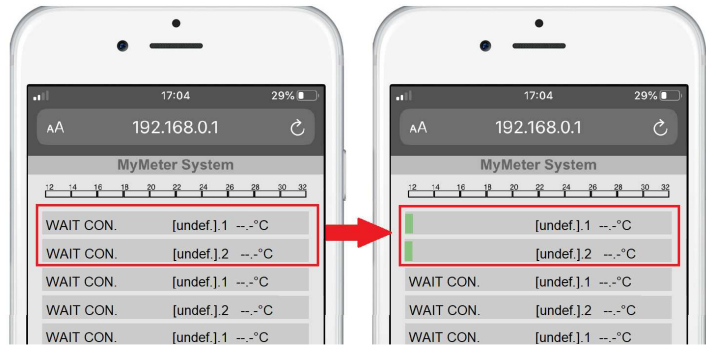

MySenseBus

Insert the supplied SpeedUp key

Wait about 30 seconds and remove the key

Repeat the operation for all connected sensors

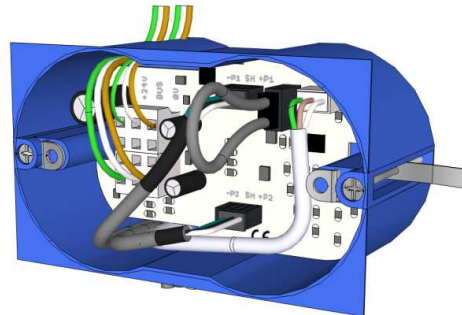
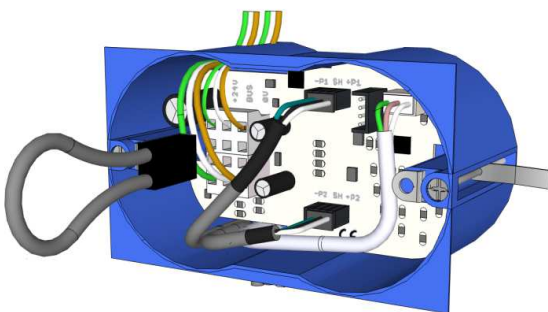

MySenseRadio acceleration

A button is located above the battery, accessible with a pencil or pen (do not use conductive materials to avoid short circuits)

Press the button and wait about 10 seconds.

Repeat the operation 5 times.

Repeat the operation for all connected sensor

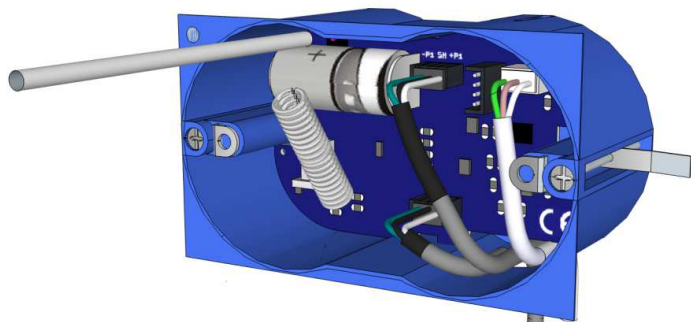
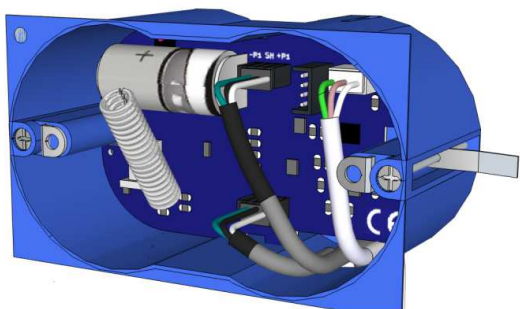

Other information

From the home screen select DATE and TIME at bottom right. Set DATE and TIME.

The system creates data history every 2 days so date and time should be accurate.

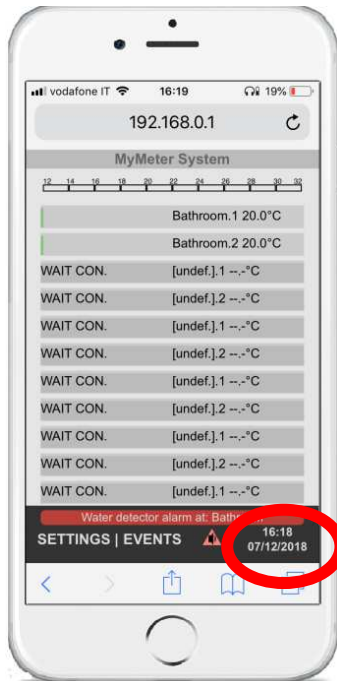

From the Home screen select SETTINGS from bottom left. (Diagram 10).

This command allows you to enter the system you can enter and edit:

- PASSWORD
- CHANNEL
- UNIT#
- BEEP ENABLE
- SENSOR

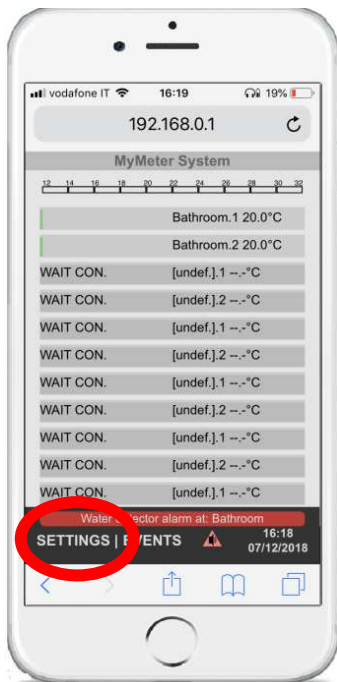

Password: Allows you to set a password that limits access to the settings page. It is recommended you enter a password to prevent access by others.

- old password: Enter the old password (or nothing if no password was set);
- new password: Enter new password, we recommend using numbers and letters but no symbols.

Note: Keep your password safe so you can be sure to retrieve it or remember it in the future.

Channel: Specify the channel which the wifi transmits (from 1 to 14) useful if interference occurs from other wifi frequencies in the area (usually within 30-50 meters) it can be easily changed which will reduce clashing frequencies. To be set if you notice the wifi in this or other devices becomes slower after the MyMeter is switched on.

Unit #: Specifies the number of control units. Set to zero if it's the only control unit accessible via wifi. If other MyMeter control units can be reached set a number between 1 and 255.

Note: changing this setting also changes the name of the wifi network which MyMeter connects to within the network. Example if you set 2 on the control unit it will show up as "MyMeter2", so once you have changed this setting (and confirmed with OK) you will need to disconnect the wifi from your smartphone and reconnect it by choosing "MyMeter2" which will now appear in the list.

Beep enable: Deselect this box to deactivate sound.

Note: When turned on the buzzer will sound for 1 second even if this setting has been disabled.

The list allows you to decide which sensors will be activated, you can also add a name as a reminder. Example, the location of the sensor. A control unit can process up to 16 sensors (each sensor can have one or more detector such as moisture and temperature).

Name: Allows you to add a name, for example "Bathroom", maximum 8 characters. In the absence of settings the proposed name is "[undef.]".

Id: Provides the sensor ID (numerical ID) this is an ID which is set on the sensor (see below). Example, if a sensor is set up in the bathroom and has been set to ID2 in setting under ID2 of control unit it can be named "bathroom".

Enabled: This shows whether a sensor has been activated or not. A tick means activated and the control unit will know that it will have to verify that it is connected. Otherwise it will be ignored and it will be disabled in the recordings (the graph bands will be grey). If a sensor is activated the control unit expects to receive data from it. Until it receives this data the control unit will indicate: WAIT CON

WARNING:

Once started the system will detect the first data within an hour of activating sensors. ALWAYS ensure the flag corresponding to the W is disabled. If a PROBE (ID) is activated with the flag but not mechanically connected to the sensor the system detects a problem and triggers the audible alarm.

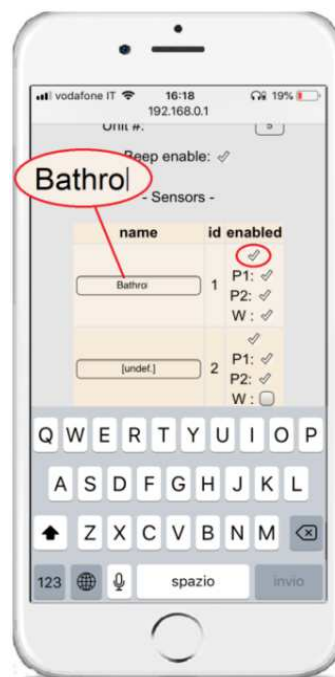

Format File System: This option is used to format the control unit's file system. It erases all the stored data and is reset back to factory default. This command could take a few minutes to complete, please wait for instructions. If the unit setting was different from zero the smartphone will disconnect from the wifi as the network name will return to default (MyMeter).

WARNING:

To avoid damaging the control unit do not remove power during this procedure; if this happens the control unit must be reset to factory default. When the procedure has finished it will ask you to confirm and restart the control unit by restarting power supply. If the wifi connection is lost during the formatting it is safe to switch it off and on after 10 minutes.

OK: Confirms the settings entered on this page. You will be automatically redirected to the home page.

Arrow: Cancels the settings entered and returns to the initial page.

Log out: This will take you out of your personal settings and any subsequent access will require a password (if it was set).

Note: authentication is different for each single device (smartphone, tablet, pc). If you have set the password and you are able to access the unit with a smartphone but at the same time another smartphone tries to access it they also have to access using the password.

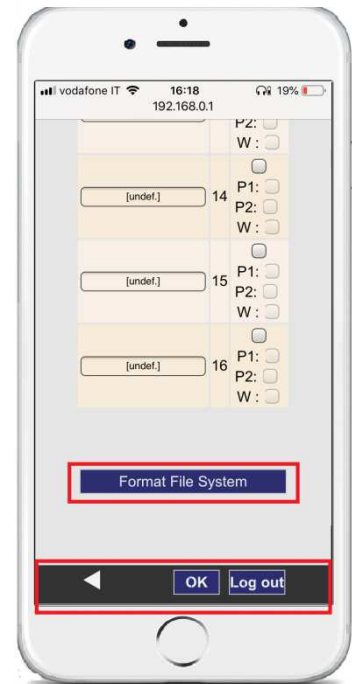

Once set up phase is completed the data can be checked at any time on the following screens:

- HOME
- DATA HISTORY
- EVENTS

HOME PAGE : Home screen where you log into MyControl CPU WiFi.

From this screen the status of all the sensors are monitored at the same time: moisture, temperature and flooding .

The moisture and temperature values are updated automatically every hour. A colored bar indicates the moisture threshold.

The GREEN bar indicates a moisture level between 12% and 18%

The YELLOW bar indicates a moisture level between 18% and 20%

The RED bar indicates a moisture level between 20% and 32%, when this threshold is exceeded the control unit MyControl CPU WiFi emits an audible alarm only silenced by connecting with a device.

A red bar at the bottom indicates the alarm.

The moisture detection range is between 12% al 32%

DATA HISTORY:

From the HOME screen you can consult the DATA HISTORY of each individual sensor by clicking on the sensor bar you can access and check all saved data. The data is saved every two days and records the level of moisture and temperature at the time of data collection.

EVENTS:

Collects all the alarm events.

Screen index

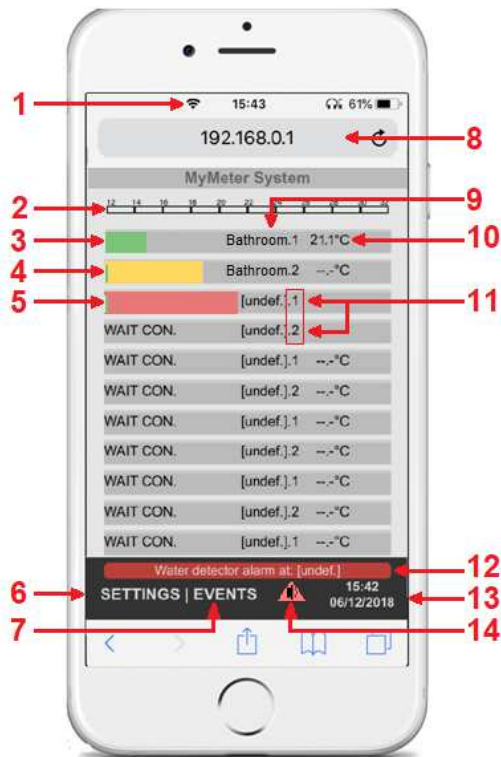

- 1) WiFi Connection
- 2) Moisture level scale from 12,5% - 32%
- 3) GREEN bar moisture threshold 12,5 - 18%
- 4) YELLOW bar moisture threshold 18 - 20%
- 5) RED bar moisture threshold 20 - 32%
- 6) Settings and set up
- 7) Event history and alarm
- 8) IP address
- 9) Sensor name you can use maximum 8 characters
- 10) Temperature C°
- 11) Sensor extension [name].1 and .2, Each sensor can have 2 reading points
- 12) Alarm bar and events
- 13) Date and time
- 14) Silence the audible alarm

WARNING:

The temperature and moisture data on the HOME screen is updated once an hour.

- 15) Storage date
- 16) Numerical order of saved data (until 99)
- 17) Return to HOME page
- 18) Sensor number
- 19) Moisture levels

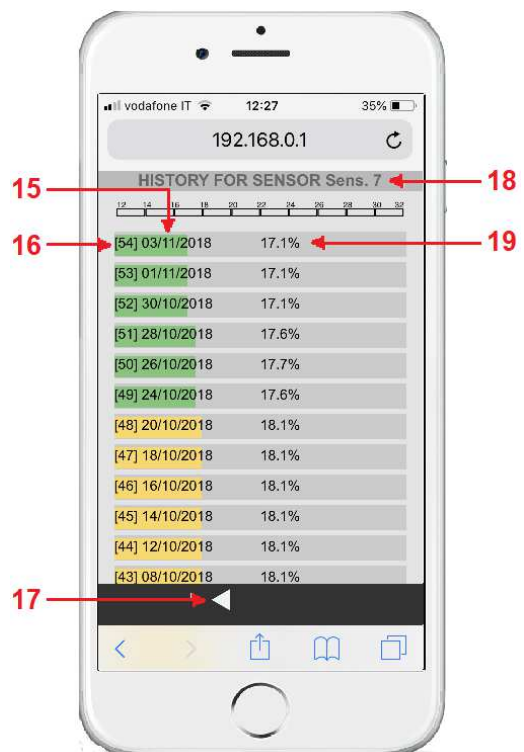
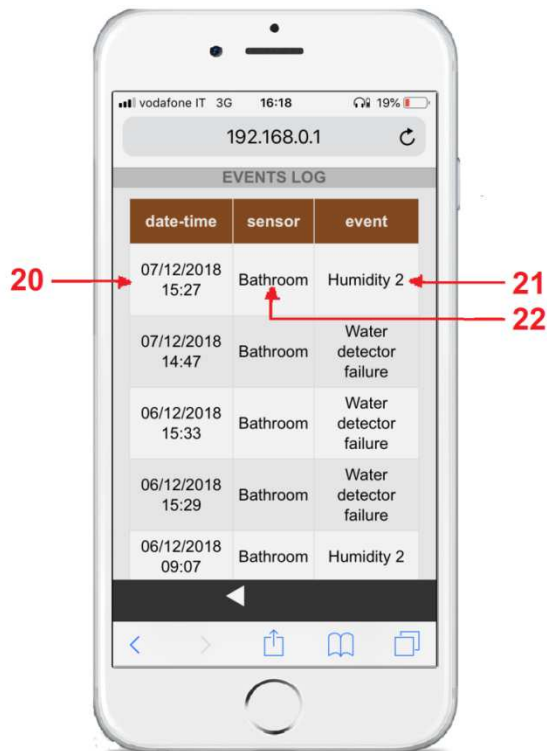

- 20) Event storage with date and time
- 21) Type of alarm
- 22) Name of sensor